

XP31 Installation

To download the complete manual



1 Installation

- This symbol indicates safety-related parts.
- This symbol indicates a danger to people or animals.
- The installation and the connection of the **XP31** must be realized in strict compliance to the local laws and regulations in use in the country of installation and by well trained personnel only. Read carefully the installation manual before performing the use and installation of the **XP31**.
- Install the **XP31** in a dry place, clean and easily accessible. When water cleaning, don't splash the box with water and keep the electronic module always clean. Insert the module in a 90x90mm slot and fix it to the back using the 4 plastic posts and the 4 thumb screws supplied. In the unlikely event of replacement due to a fault in the **XP31**, cut off the supply voltage, then remove the connection connectors, unscrew the 4 wing screws on the back of the module, remove the fixing columns and remove the module from the front.
- Check periodically the functionality of the module. Unit break down might happen suddenly! To prevent damages always include in the system an independent alarm and check it minimally once daily.
- Keep voltage off before making any operation on the system; always provide the system with a suitable automatic switch or disconnector on the primary side of the mains supply.

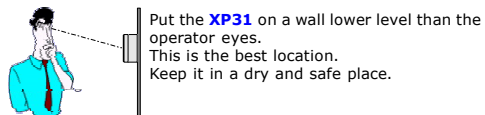

2 XP31 connection

Connection of inputs

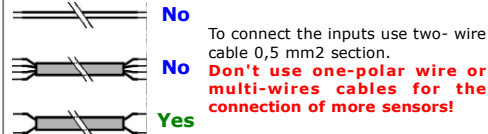

To connect the inputs use two-wire cable 0,5 mm2 section.
Don't use one-polar wire or multi-wires cables for the connection of more sensors!

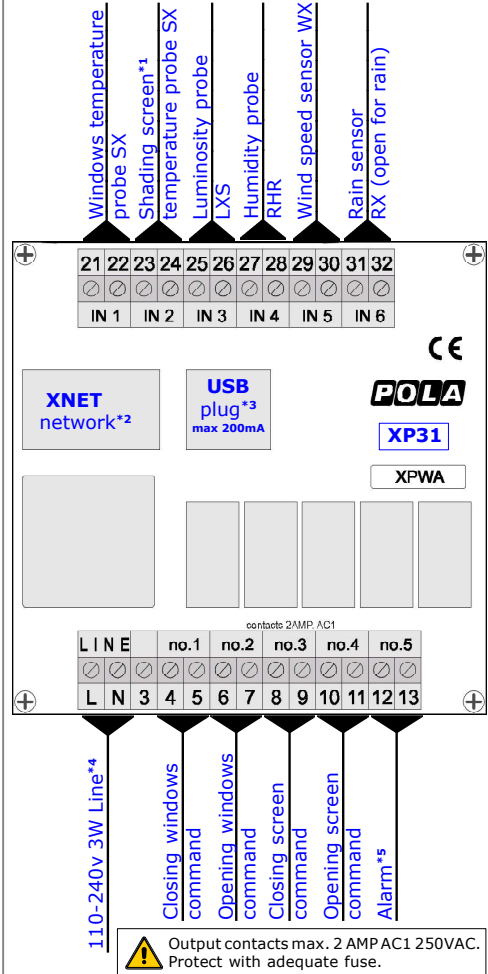

- *1 Thermal trip external contact: closing this input activates the **Motor protection intervention** alarm. During this condition the temperature probe will not be shown (**T. Block** will appear).
- *2 Optional: for details see **XP31 Net** manual.
- *3 **XP31** has a USB plug on the back. When selecting the **USBP** option you can get a USB plug with a (IP65) protection cap externally mounted so you can access the USB without having to go to the back of the unit.
- *4 Always provide the system with a suitable automatic switch or disconnector on the primary side of the mains supply.
- *5 Alarm contact that open for intervention alarm or for black-out.

3 Windows temperature probe connection SX (if any)

Activable in Installation > Plant constan > Plant data > Windows presence = YES

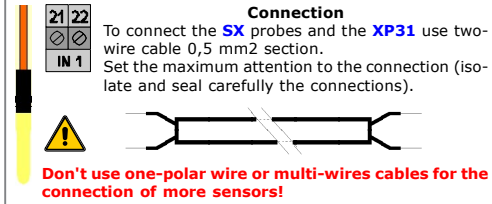

4 Screen temperature probe connection SX (if any)

Activable in Installation > Plant constan > Plant data > Screen temperatura probe = YES

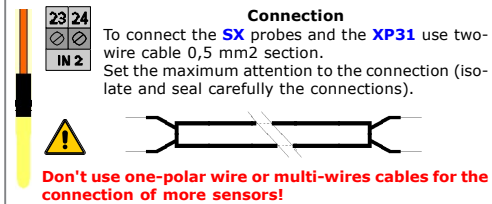

5 Motor thermal signal contact connection (if any)

The intervention of the external thermal snap contact of the motors triggers the alarm and it is recorded in the archives.

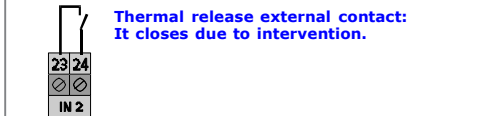

Note: the **IN 2** input (terminals 23-24) is the same used for the connecting the screen temperature probe (if present in the system): in this case both must be connected to this output (in parallel).

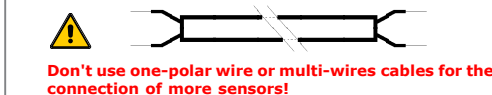

6 Luminosity probe connection LXS (if any)

Activable in Installation > Plant constan > Plant data > Screen presence = YES

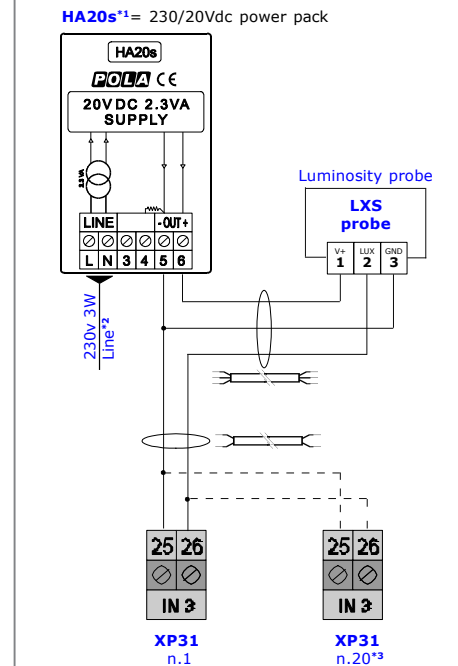

- *1 **LXS** (brightness), **RHR** (humidity), **RX** (rain), they all share the same **HA20s** power supply.
- *2 Always provide the system with a suitable automatic switch or disconnector on the primary side of the mains supply.
- *3 Wiring to be done when connecting one brightness probe only to several **XP31** units (max 20 units).

If the **W02** option is present (IP54 box for wall mounting of the **XP31** module), the **HA20s** power supply can be hooked inside the box on the din rail in the position shown in figure.



7 Humidity probe connection RHR (if any)

Activable in Installation > Plant constan > Plant data > Humidity probe = YES

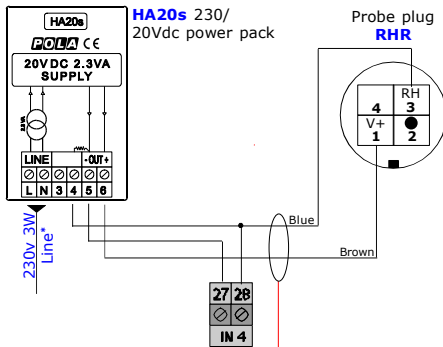

Connection

⚠ To connect the **RHR** probes and the **XP31** use two-wire cable 0,5 mm² section. Set the maximum attention to the connection (isolate and seal carefully the connections).

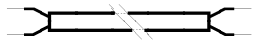

Don't use one-polar wire or multi-wires cables for the connection of more sensors!

* Always provide the system with a suitable automatic switch or disconnector on the primary side of the mains supply.

INSTALLATION

For optimum measurements **RHR** should be installed at the centre of the area to be monitored, accessible for maintenance work.

CLEANING

Remove the sensor before cleaning and disinfection. Remember to attach the sealing plug to the connector when the sensor has been removed. A missing screw plug leads to corrosion of the connector.



Postadress:

TRÄDGÅRDSTEKNIK AB
Helsingborgsvägen 578, Varalöv
262 96 ÄNGELHOLM

URL:

www.tradgardsteknik.se
E-postadress:
info@tradgardsteknik.se

8 Wind sensor connection WX (if any)

Activable in Installation > Plant constan > Plant data > Wind sensor = YES



The **WX** wind sensor has to be positioned outdoor so it can detect the wind speed.

To connect the **WX** sensor and the **XP31** use two-wire cable 0,5 mm² section. Set the maximum attention to the connection (isolate and seal carefully the connections).

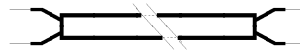

Don't use one-polar wire or multi-wires cables for the connection of more sensors!

10 Rain sensor connection RX (if any)

Activable in Installation > Plant constan > Plant data > Rain sensor = YES

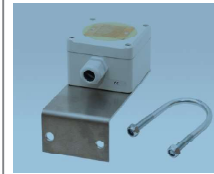

HA20s^{*1} = 230V/20Vdc power pack

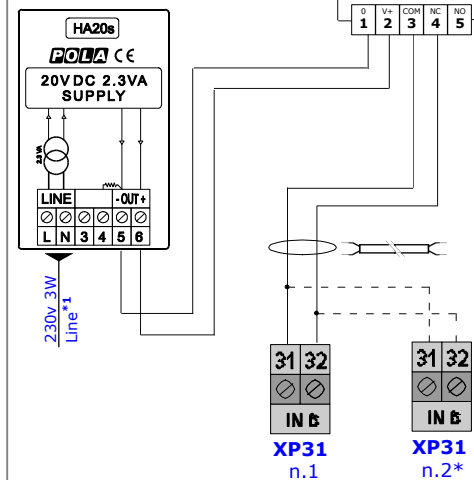

* Wiring to be done when connecting one luminosity probe only to several **XP31** units (max 10 units).

RX is a rain sensor designed to detect rainfall (rain, snow). A heating element is incorporated in the sensor.

NOTE: the sensor reacts even in the presence of snow. If the snow is "dry" and falls along with strong wind, it will not function properly.

The sensor can be installed on the wall by screws or on a pole by the supplied bracket.

Mount the sensor with 5° angle.

If necessary, clean the sensor surface. It is recommended to clean it once a year, based on the environmental conditions.

IMPORTANT: do not use aggressive detergents or sharp tools.

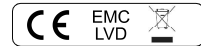

XP31	
Power supply	
Line voltage	110-240Vac
Frequency	50/60Hz
Power consumption	3W
Case	
Case material	ABS
Dimensions	96x96x53mm
Weight	Kg 0,25
Protection degree	IP54
Temperature range	
Operational (maximum altitude 2000mt)	-10...+50°C
Storage	-40...+80°C
Relative humidity	<95%, uncondensed

POLA®

*1 Always provide the system with a suitable automatic switch or disconnector on the primary side of the mains supply.

*2 **LXS** (brightness), **RHR** (humidity), **RX** (rain), they all share the same **HA20s** power supply.